

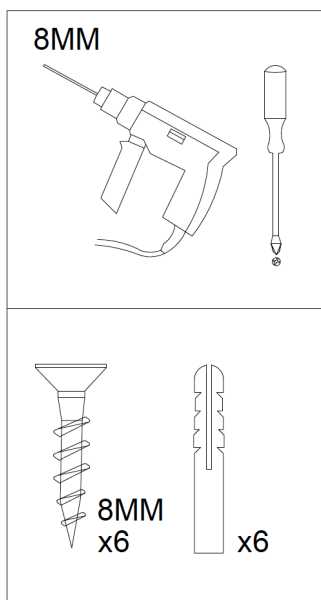

Assembly instructions

- 1- Present, level and mark the 4 holes.
- 2- Drill and place dowels.
- 3- Present and screw.

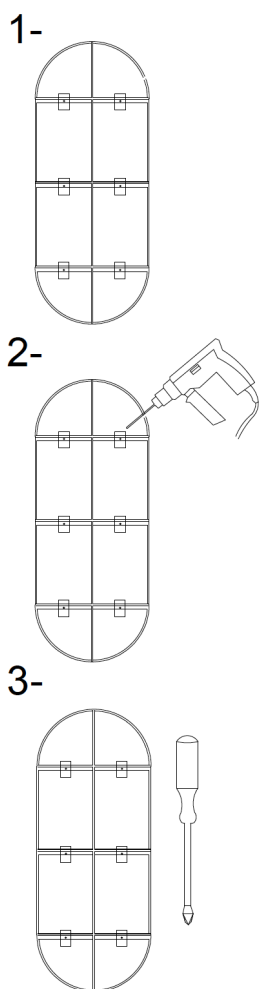

Estantería GRAPHIC 3
Diseño: Clara del Portillo
Alex Selma

i@dae.es · Rambla dels Països Catalans, 10 Nave 25, Vilanova i la Geltrú · Postal code: 08800, Barcelone · Phone: +34 93.815.74.87

General

Assembly instructions

Read these warnings carefully.

These shelves are designed to be fixed to the wall.

Due to the different types of materials existing today in construction, we do not supply wall anchoring screws. Check with the manufacturer of the material for advice.

The breach of these warnings and the non-use of the products for the purposes that are designed, exempts us from any responsibility.